

## Operating Instructions

# Sartorius Talent, M-power Sartorius Gem, Gold

Electronic Analytical and Precision  
Balances and Precious Metal Scales

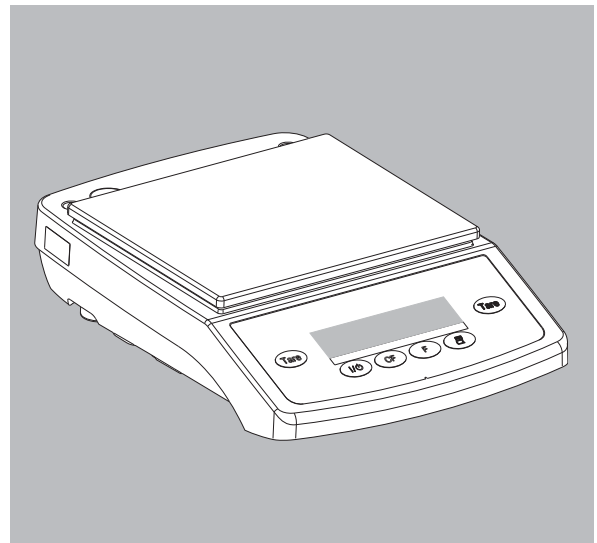
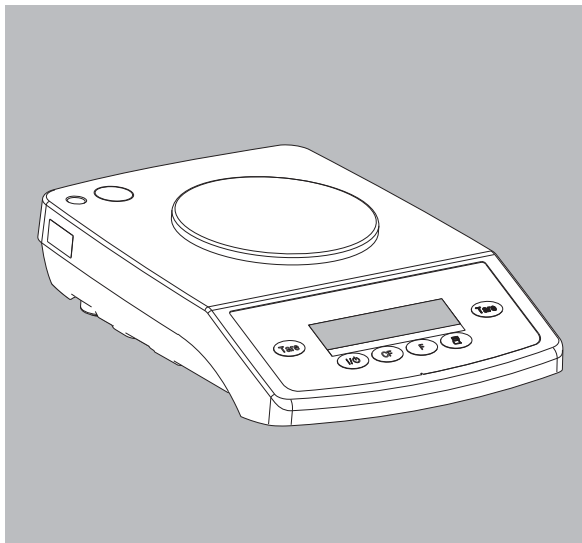
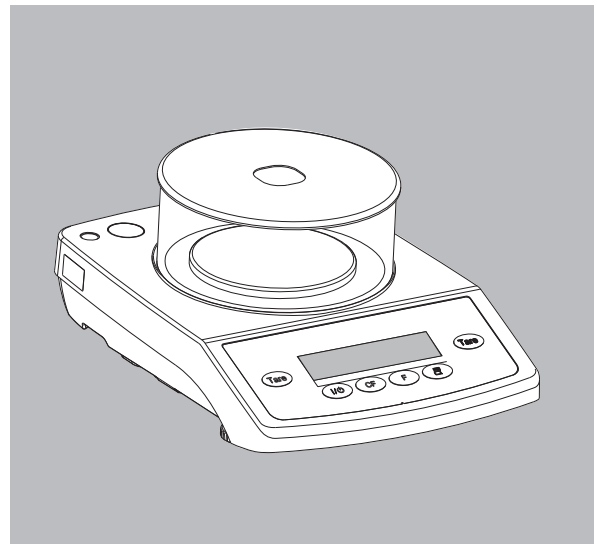
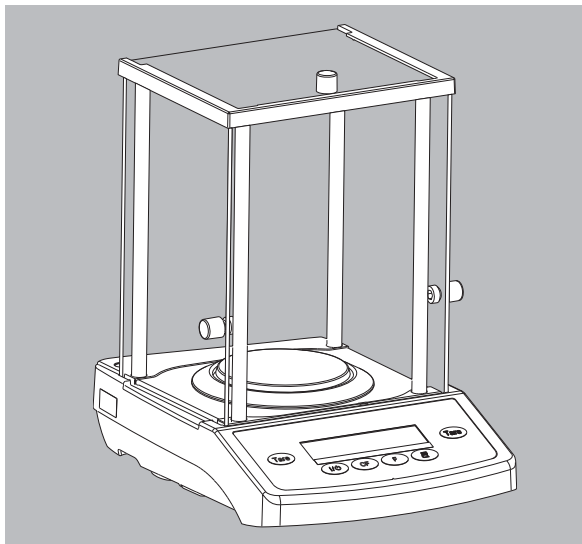

# Contents

Contents . . . . .	2
<b>Warnings and Safety Precautions</b> . . . . .	2
<b>Getting Started</b> . . . . .	3
<b>Operation</b> . . . . .	7
Overview of Display and Operating Elements . . . . .	7
Basic Weighing Function . . . . .	8
Calibration/Adjustment . . . . .	9
<b>Application Programs</b> . . . . .	10
Net-Total Formulation/ Second Tare Memory . . . . .	10
Counting . . . . .	11
Weighing in Percent . . . . .	12
Weigh Averaging . . . . .	13
Toggleing Between Weight Units . . . . .	14
<b>Configuring the Balance/ Scale (Menu Codes)</b>	
Setting the Parameters (Menu Codes) . . . . .	15
Balance/Scale Operating Menu (Overview) . . . . .	16
ISO/GLP-compliant Printout . . . . .	18
Data Interface . . . . .	20
<b>Error Codes</b> . . . . .	21
<b>Care and Maintenance</b> . . . . .	22
<b>Instructions for Recycling</b> . . . . .	23
<b>Overview</b>	
Specifications . . . . .	24
Accessories (Options) . . . . .	33
Declaration of Conformity . . . . .	35

# Warnings and Safety Precautions

## Safety

- To prevent damage to the equipment, please read these operating instructions carefully before using your balance/scale.
- ⚠ Do not use this balance/scale in a hazardous area/location.
- ⚠ Use only a commercially available non-rechargeable or rechargeable battery: 8× AA, Mignon
- ⚠ Make absolutely sure to unplug the balance/scale from AC power before you connect or disconnect a peripheral device.
- ⚠ Exposure to excessive electromagnetic disturbance can cause the readout value to change. Once the disturbance has ceased, the instrument can be used again in accordance with its intended use.

## Setting up the Balance/Scale

- ⚠ Warning when using pre-wired RS-232 connecting cables: The pin assignments in RS-232 cables purchased from other manufacturers may be incompatible with Sartorius balances/scales. Be sure to check the pin assignment against the chart on page 19 before connecting the cable, and disconnect any lines that do not match.
- Connect only Sartorius accessories and options, as these are optimally designed for use with your Sartorius balance/scale. Do not try to solve any problems on your own. The operator shall be responsible for any modifications to Sartorius equipment and for any connections of cables or equipment not supplied by Sartorius and must check and, if necessary, correct these modifications and connections. On request, Sartorius will provide information on the minimum operating specifications (in accordance with the standards for defined immunity to interference).
- Do not open the balance/scale housing. If the seal is broken, this will result in forfeiture of all claims under the manufacturer's warranty.

---

# Getting Started

## Storage and Shipping Conditions

- Do not expose the balance/scale to extreme temperatures, blows, shocks, vibration or moisture.

## Unpacking the Balance/Scale

- After unpacking the balance/scale, check it immediately for any visible damage
- If you see any sign of damage, proceed as directed in the chapter entitled “Care and Maintenance,” under the section on “Safety Inspection”
- Save the box and all parts of the packaging until you have successfully installed your balance/scale in case you need to return it. Before packing your balance/scale, unplug all connected cables to prevent damage.

## Equipment Supplied

- Balance/scale
- Weighing pan
- Pan support (only on models with a round weighing pan)
- Gem tray (only with GE and GD models)
- AC adapter, plug type

Additionally supplied with AZ214, AZ124, AZ64, TE214S, TE124S, TE64, GD603, GD103, GD502-DS models:

- Shield ring
- Shield plate
- Dust cover

Additionally supplied with TE313S-DS, TE153S-DS models:

- Draft shield chamber with sliding doors

Additionally supplied with TE313S, TE153S, GD252 models:

- Glass draft shield with cover

Additionally supplied with GD252-DS, GD502-DS models:

- Draft shield chamber with sliding doors
- 50-g calibration weight (F1)

## Installation Instructions

When choosing a location to set up your balance/scale, observe the following:

- Avoid placing the balance/scale in close proximity to a heater or otherwise exposing the balance/scale to heat or direct sunlight
- Protect the balance/scale from drafts that come from open windows or doors
- Avoid exposing the balance/scale to extreme vibrations during weighing
- Do not expose the balance/scale to extreme moisture over long periods

## Conditioning the Balance/Scale

Moisture in the air can condense on the surfaces of a cold balance/scale whenever it is brought into a substantially warmer place.

If you transfer the balance/scale to a warmer area, make sure to condition it for about 2 hours at room temperature, leaving it unplugged from AC power.

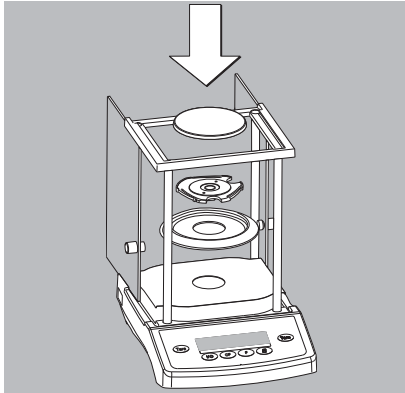

### Setting up the Balance/Scale

Balances/scales with a draft shield chamber with sliding doors

- Place the components listed below inside the chamber in the order given:
  - Shield plate
  - Shield ring (not for models TE313S-DS, TE153S-DS)
  - Pan support
  - Weighing pan
  - Gem tray (only with GD models)

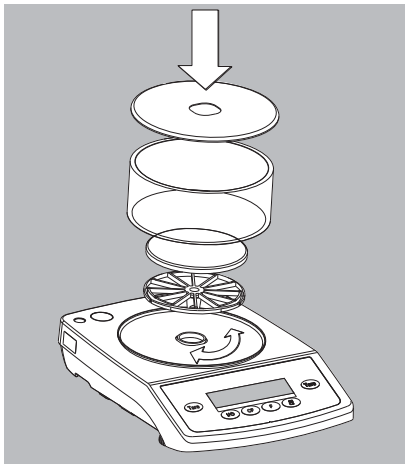

Balances/Scales with a Glass Draft Shield

- Place the components listed below inside the chamber in the order given:
  - Draft shield base – place it on the balance/scale so that the edge for fitting the glass draft shield faces upwards and turn it until it is firmly in place
  - Pan support
  - Weighing pan
  - Glass draft shield
  - Gem tray (only with GD models)
  - Draft shield cover – place it on the balance/scale so that the edge faces downwards

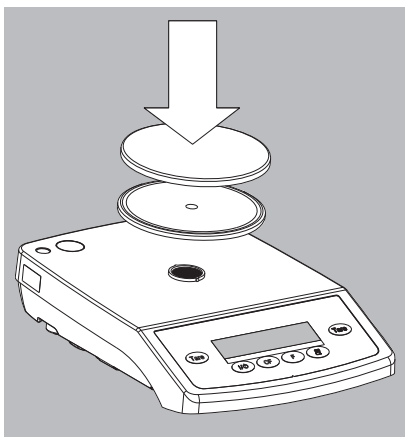

Balances/Scales with a Round Weighing Pan

- Place the components listed below inside the chamber in the order given:
  - Pan support
  - Weighing pan
  - Gem tray (only with GE models)

Balances/Scales with a Rectangular Weighing Pan

- Place the weighing pan on the balance/scale
- Gem tray (only with GE models)

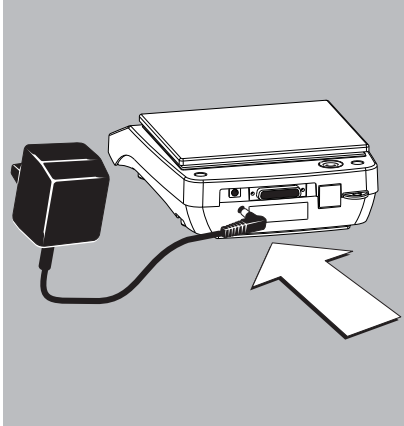

### Connecting the Balance/Scale to AC Power/ Safety Precautions

Use only original Sartorius AC adapters:

- for Europe: 6971948
- Insert the right-angle plug into the jack
- Plug AC adapter into electrical outlet

The ground terminal is connected to the balance/scale housing, which can be additionally grounded for operation.

### Using a Non-Rechargeable/Rechargeable Battery

(not for models AZ214, AZ124, AZ64, AZ3102, AZ1502, TE214S, TE124S, TE64, GD603, GD103, GD502-DS, GD252, TE313S, TE153S, GE3102, TE3102S, GE2102, TE1502S, GE1302)

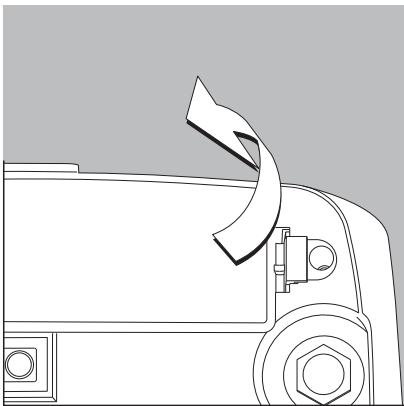

- A non-rechargeable or rechargeable battery is not included with the equipment supplied

⚠ Use only a commercially available non-rechargeable (8× AA/Mignon) or rechargeable battery

⚠ When using a rechargeable battery, always use an external charger to recharge the battery

- Lay the balance/scale on its side
- Lift the compartment cover

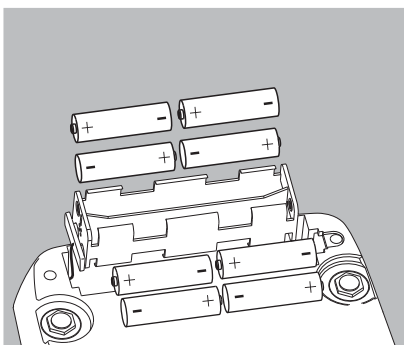

- Insert the non-rechargeable (8× AA/Mignon) or rechargeable batteries into the compartment

○ Make sure to connect the positive and negative poles correctly

- Close the battery compartment:  
Press down on the cover until it clicks into place

⚠ All used batteries are classified as waste that requires special handling (not “household” waste). Dispose of rechargeable batteries in accordance with the applicable special waste disposal regulations

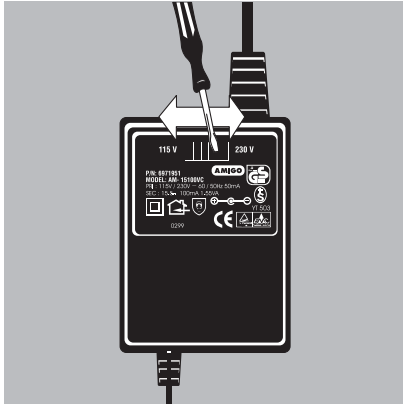

### Selecting the Line Voltage (Mains Voltage) (Optional)

Use the following original AC adapters for selecting the line voltage:

- AC adapter TNG8 order no. 6971951 (universal) or
- AC adapter TNG8 order no. 6971952 (for the U.K.)
- Use the switch to toggle between 230 V and 115 V

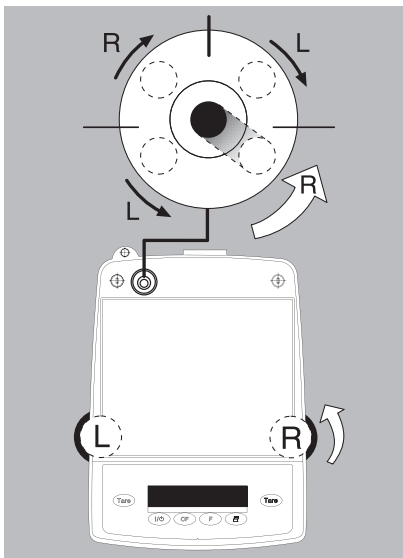

### Leveling the Balance/Scale

(only for models AZ..., GD..., GE3102, GE2102, GE1302, TE...-L, TE214S, TE124S, TE64, TE313S, TE153S, TE3102S, TE1502S)

Level the balance/scale any time you set it up in a new location. Use only the 2 front feet of the balance/scale for leveling.

- Turn the 2 rear feet until they are in position (only on models GE3102, GE2102, GE1302, TE3102, TE1502)
- Turn the 2 front feet as shown here in the illustration until the air bubble is centered in the level indicator
- > In most cases, this will require several adjustment steps

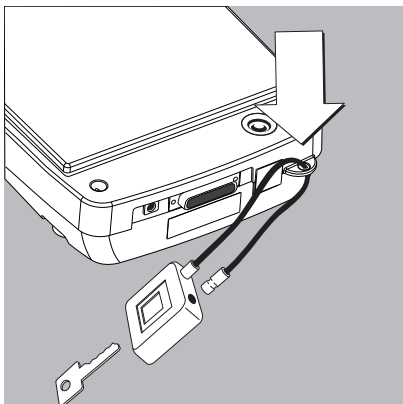

### Anti-theft Locking Device

To protect against theft, use the mounting lug on the rear panel of the balance/scale.

- Secure the balance/scale at the place of installation, for example with a chain or a lock

# Operation

## Overview of Display and Operating Elements

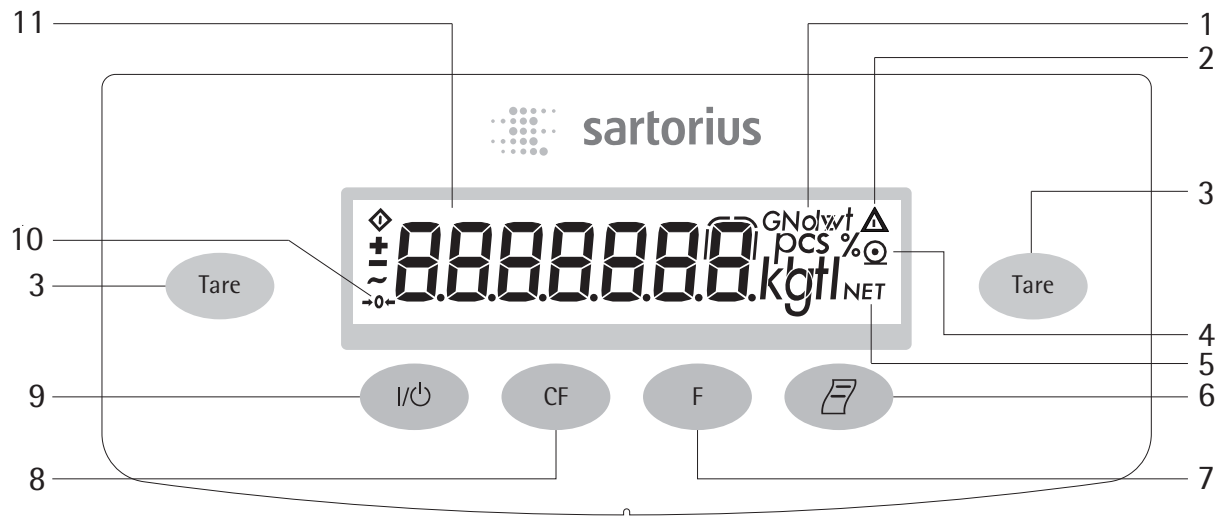



Position	Designation
1	Weight units
2	Calculated-value indicator (i.e., not a weight value)
3	Taring
4	Symbol: "Printing mode active"
5	Symbol: Gross or net value
6	Data output: Press this key to send readout values to the built-in data interface.
7	Start an application program

Position	Designation
8	Delete (Clear Function) This key is generally used to cancel functions: – Quit application program – Cancel calibration/adjustment routine   Exit the operating menu
9	On/off
10	Symbols for zero range (verified models only)
11	Weight value displayed in selected weight unit

## Basic Weighing Function

### Preparation

- Turn on the balance/scale: Press 
- To change configurations: See the chapter entitled “Configuring the Balance/Scale”
- To tare the balance/scale: Press 

### Additional Functions:

- To turn off the balance/scale: Press 

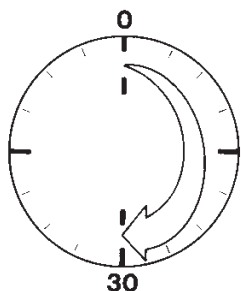





### Warmup Time

To ensure accurate results, the balance must warm up for 30 minutes before operation. Only after this time will the balance have reached the required operating temperature.

### Example

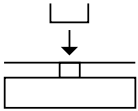
#### Basic weighing

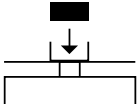
Step	Key (or instruction)	Display/Printout
1. Turn on the balance/scale		
Self-test is performed		
2. Place container on balance/scale (here: 52 g)		+ 52.0 g
3. Tare the balance/scale		+ 0.0 g
4. Place sample in container on balance/scale (here: 150.2 g)		+ 150.2 g

# Calibration/Adjustment

## Available Features

Calibration/adjustment can only be performed when

- there is no load on the balance/scale,
- the balance/scale is tared,
- the internal signal is stable.



If these conditions are not met, an error message is displayed. Otherwise, the weight required for calibration/adjustment is displayed (see “Accessories” for calibration weights).

On AZ and TE models, you can use any of the following weight units to calibrate/adjust: g, kg\*, lb (menu code 1.4.x)

You can block calibration/adjustment of the balance/scale:

- Select menu code 1.5.3)

## Example

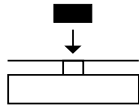
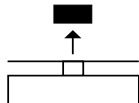
Step	Key (or instruction)	Display/Printout
1. Tare the balance/scale		0.0 g
2. Begin calibration Calibration weight is displayed without weight unit (here: 1000 g)	 >2 sec.	+ 1000.0
3. Place the indicated calibration weight on the balance/scale		1000.0
After calibration, the calibration weight is displayed with wt. unit		+ 1000.0 g
4. Remove the calibration weight		0.0 g

\* = not on models with a readability of 0.1 mg

# Application Programs

## Net-Total Formulation/Second Tare Memory

With this application program you can weigh in components for formulation of a mixture.

### Preparation

Configure the Net-Total Formulation/Second Tare Memory application in the operating menu: See "Configuring the Balance/Scale." Menu code: 2.13

### Example

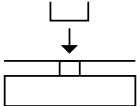
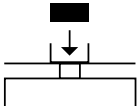
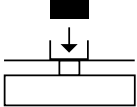
Step	Key (or instruction)	Display/Printout
1. Place an empty container on the balance/scale		+ 65.0 g
2. Tare the balance/scale	(Tare)	+ 0.0 g
3. Add the first component		+ 120.5 g
4. Store the first component weight. If the print format is set to include data ID codes, the following is printed	(F)	0.0 g <sub>NET</sub>
5. Add the next component		N1 + 120.5 g + 70.5 g
6. Store the 2nd component weight	(F)	0.0 g <sub>NET</sub>
7. Add further components, if desired	As described for steps 5 and 6	
8. Display total weight and fill to desired final weight	(CF)	+ 191.0 g



# Weighing in Percent

## Purpose

This application program allows you to obtain weight readouts in percent which are in proportion to a reference weight.

## Preparation

- Configure the Weighing in Percent application in the operating menu: See “Configuring the Balance/Scale.” Menu code: 2. 1. 5

## ○ Reference percentage:

Code 3. 3. 1      5 %  
 Code 3. 3. 2      10 % (factory setting)  
 Code 3. 3. 3      20 %  
 Code 3. 3. 4      50 %  
 Code 3. 3. 5      100 %

## ○ Storage parameter













(display accuracy for counting)  
 Code 3. 4. 1      Standard resolution: With stability (factory setting)  
 Code 3. 4. 2      With 10 times higher stability than standard  
 See also “Configuring the Balance/Scale”

## Example

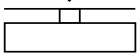
Determine an unknown percentage: store the weight on the balance/scale as a reference percentage

Menu: Application program: Weighing in Percent (menu code 2. 1. 5)

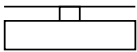
Menu: Reference percentage: 100 % (menu code 3. 3. 5)

Step	Key (or instruction)	Display/Printout
1. Tare the balance/scale		0.0 g
2. Display the reference percentage:	 >2 sec.	rEF 100
3. Place the reference weight for 100 % on the balance/scale (here: 222.5 g)	 ↓ 	+ 222.5 g
4. Start the application; if the print format is set to include data ID codes the following is printed		+ 100.00 % Wxx% + 222.500 g
5. Place an unknown weight on the balance/scale (here: 322.5 g)	 ↓ 	+ 144.94 %
6. Display weight		+ 322.5 g
7. Display percentage		+ 144.94 %
8. Unload the balance/scale	 ↑ 	0.00 %
9. Delete the reference percentage		
10. Repeat the procedure starting from step 5, if desired.		

# Weigh Averaging

## Purpose

Use this program to determine weights under unstable ambient conditions. In this program, the balance/scale calculates the weight as the average value from a defined number of individual weighing operations. These weighing operations are also known as “subweighing operations” or “subweighs.”

○ Number of subweighs for weigh averaging:

- 3.3.1 5 subweighs
- 3.3.2 10 subweighs (factory setting)
- 3.3.3 20 subweighs
- 3.3.4 50 subweighs
- 3.3.5 100 subweighs

## Preparation







- Configure the Weigh Averaging application in the operating menu: See “Configuring the Balance/Scale.”  
Menu code: 2.1.12

See also “Configuring the Balance/Scale”

## Example

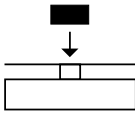
Determine the weight of a sample in extremely unstable ambient conditions by calculating the average of 10 subweighing operations.

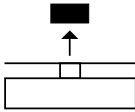
Menu: Application program: Weigh Averaging (menu code 2.1.12)

Step	Key (or instruction)	Display/Printout
1. Tare the balance/scale		0.0 g
2. Display the number of subweighs (here: 10)	 >2 sec.	rEF 10 (briefly)
3. Place sample on the balance/scale (weight readout fluctuates)		8888
4. Start measurement		8888 10 8 8 ...
After 10 subweighs		+ 275.5 g $\Delta$
If the print format is set to include data ID codes, the following is printed		Res + 275.5 g
5. Unload the balance/scale		+ 275.5 g $\Delta$ (stable display)
6. Delete the result		
7. Repeat the procedure starting from step 3, if desired.		

# Toggle Between Weight Units

With this application program you can toggle the display of a weight value back and forth between two weight units.

Configure the “Toggle Weight Units” application in the operating menu:  
See “Configuring the Balance/Scale.” Menu code 2. 1. 2

Menu code	Unit	Conversion factor	Abbr. on printout
1. 7. 2 o 3. 1. 2 o	Grams	1	g
1. 7. 3 1) 3. 1. 3 1)	Kilograms	0.00100000000	kg
1. 7. 4 3. 1. 4	Carats	5	ct
1. 7. 5 3. 1. 5	Pounds	0.00220462260	lb
1. 7. 6 3. 1. 6	Ounces	0.03527396200	oz
1. 7. 7 3. 1. 7 <sup>2)</sup>	Troy ounces	0.03215074700	ozt
1. 7. 8 3. 1. 8	Hongkong taels	0.02671725000	tlh
1. 7. 9 3. 1. 9	Singapore taels	0.02645544638	tls
1. 7. 10 3. 1. 10	Taiwanese taels	0.02666666000	tlt
1. 7. 11 3. 1. 11	Grains	15.43235835000	GN
1. 7. 12 3. 1. 12	Pennyweights	0.64301493100	dwt
1. 7. 13 3. 1. 13	Milligrams	1000	mg
1. 7. 14 3. 1. 14	Parts per pound	1.12876677120	/lb
1. 7. 15 3. 1. 15	Chinese taels	0.02645547175	tlc
1. 7. 16 3. 1. 16	Mommies	0.26670000000	mom
1. 7. 17 3. 1. 17	Austrian carats	5	K
1. 7. 18 3. 1. 18	Tola	0.08573333810	tol
1. 7. 19 3. 1. 19	Baht	0.06578947437	bat
1. 7. 20 3. 1. 20	Mesghal	0.21700000000	MS

o = Factory setting

1) = not for models with a readability of  $\leq 0.2$  mg

2) = Factory setting only for GE models

## Function

- To toggle the display between the 1st and 2nd weight units:  
Press the  key















# Configuring the Balance/Scale

## Setting the Parameters (Menu Codes)

You can configure your balance/scale to meet individual requirements by selecting from the parameters available in the menu.

Example: Adapt the balance/scale to unstable ambient conditions

Menu code 1. 1. 4

Step	Key (or instruction)	Display
1. Turn off the balance/scale		
2. Turn the balance/scale back on; while all segments are displayed	  briefly	1.
<input type="radio"/> To navigate within a menu level; the last menu option is followed by the first option	 repeatedly	2. ⋮ 9. 1.
3. Select the 2nd menu level		1. 1.
4. Select the 3rd menu level		1. 1. 2 o
5. In Menu Level 3: Select the desired option	 repeatedly	1. 1. 4
6. Confirm new setting; the “o” indicates the currently set option	 >2 sec.	1. 1. 4 o
<input type="radio"/> Select the next menu level (here: move from the 3rd to the 1st level)		1.
<input type="radio"/> Set other menu codes, if desired	 , 	
7. Store parameter settings and exit operating menu or	 >2 sec.	
<input type="radio"/> Exit operating menu without storing changes		
> Restart the application		0.0 g

## Balance/Scale Operating Menu (Overview)

o Factory setting

√ User setting

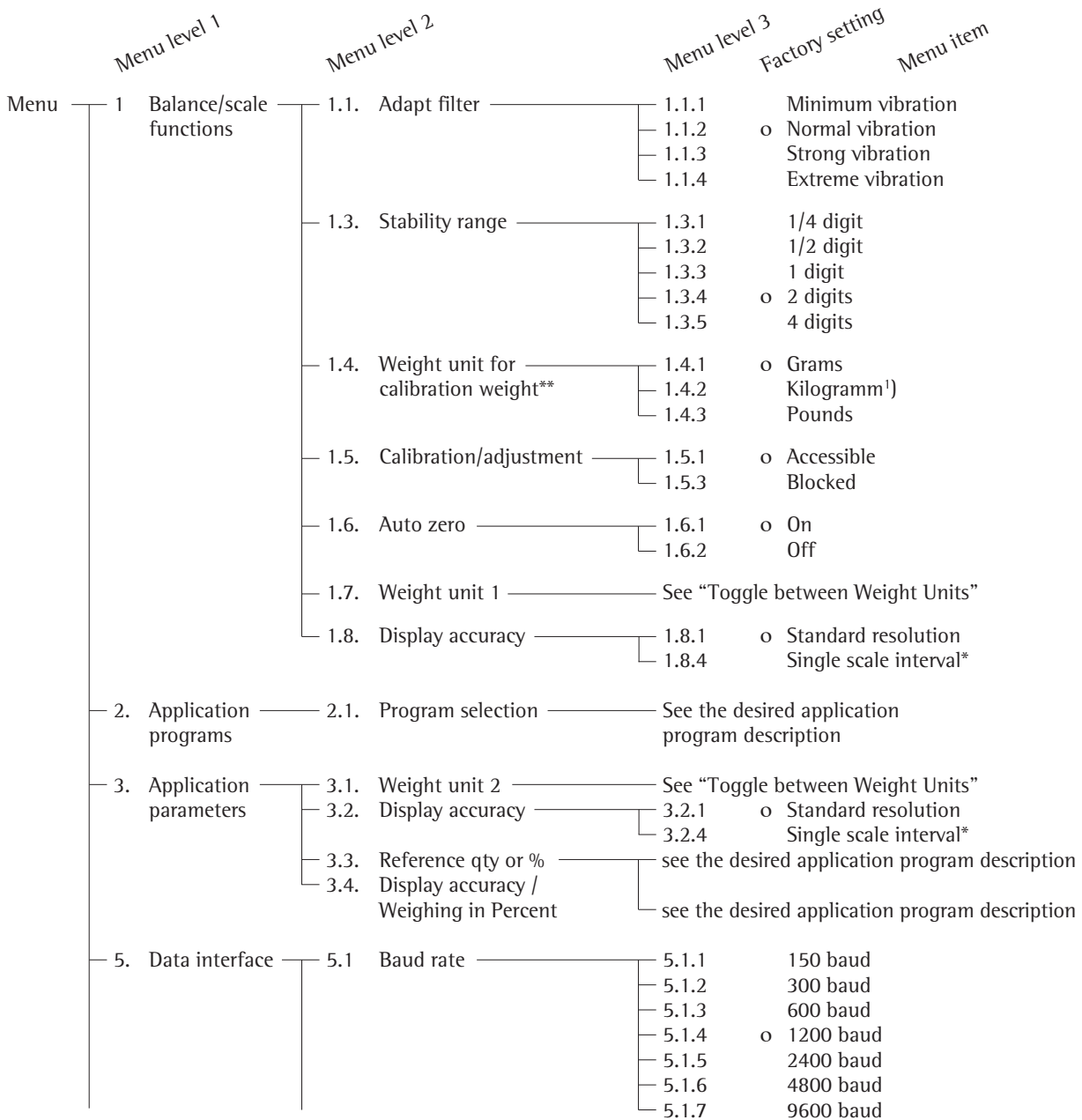

\* = only for GD, GE models

\*\* = only for TE models

<sup>1)</sup> = not for models with a readability of 0.1 mg

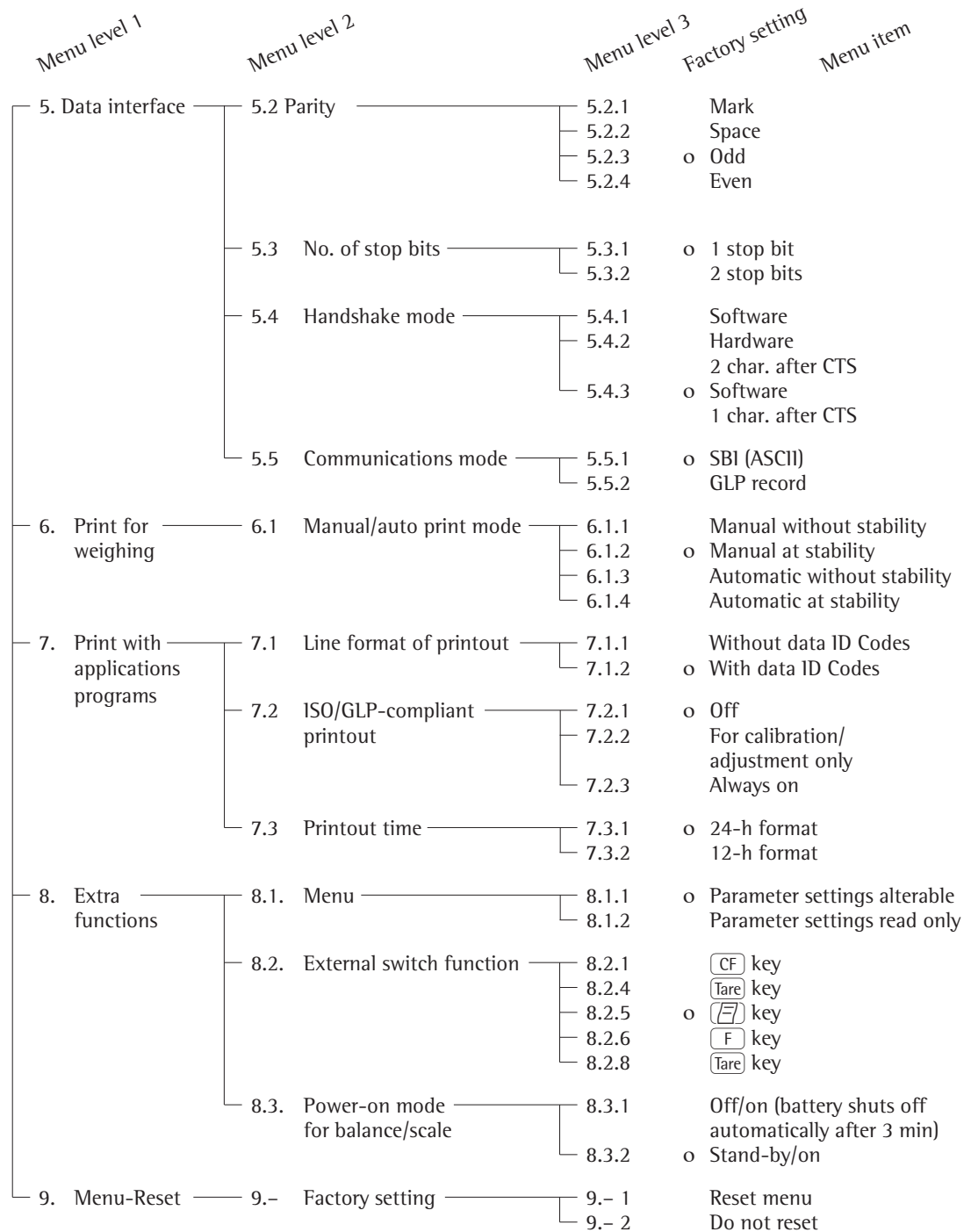

---

# ISO/GLP-compliant Printout

## Features

You can have the parameters pertaining to the ambient weighing conditions printed before (GLP header) and after (GLP footer) the values of a weighing series.

These parameters include:

GLP header:

- Date
- Time at beginning of measurement
- Balance/scale manufacturer
- Balance/scale model
- Balance/scale serial number
- Software version number
- Identification number of the current sampling operation

GLP footer:

- Date
- Time at end of measurement
- Field for operator signature

⚠ The record can only be output to a Sartorius data printer YDP20-OCE.

## Settings

- Set the following menu codes (see “Configuring the Balance/Scale”):
  - GLP-compliant record: menu code 5 5 2
  - ISO/GLP-compliant record after calibration/adjustment only: menu code 7 2 2 or ISO/GLP-compliant record always on: menu code 7 2 3
  - Line format for printout: With data ID codes – 22 characters: menu code 7 1 2
  - Printout date/time:
    - 24-h format: menu code 7 3 1
    - 12-h format: menu code 7 3 2
- ⚠ No ISO/GLP-compliant record is output if any of the following settings are configured:
  - menu codes 6 1 3, 6 1 4 (automatic printout) and 7 1 1

## Function Keys

Press **[E]** to output header and first measured value.

- > Header is output the first time **[E]** is pressed

To output header and reference data automatically with an application program active: Press **[F]**

End application program:  
End application program and output GLP footer: Press **[CF]**

The ISO/GLP-compliant record can contain the following lines:

-----	Dotted line
17-Jan-2003 10:15	Date/time (beginning of measurement)
SARTORIUS AG	Balance/scale manufacturer
Mod. TE6100	Balance/scale model
Ser. no. 10105355	Balance/scale serial number
Ver. no. 00-19-41	Software version
ID	ID
-----	Dotted line
L ID	Measurement series no.
wRef + 21.14 g	Counting: Reference weight
Qnt + 235 pcs	Counting result
Qnt + 567 pcs	Counting result
-----	Dotted line
17-Jan-2003 10:20	Date/time (end of measurement)
Name :	Field for operator signature
	Blank line
-----	Dotted line

ISO/GLP-compliant printout for external calibration/adjustment

-----	Dotted line
17-Jan-2003 10:30	Date/time (beginning of measurement)
SARTORIUS AG	Balance/scale manufacturer
Mod. TE6100	Balance/scale model
Ser. no. 10105355	Balance/scale serial number
Ver. no. 00-19-41	Software version
ID	ID
-----	Dotted line
Cal. Extern	Calibration/adjustment mode
Set + 5000.0 g	Calibration weight
-----	Dotted line
17-Jan-2003 10:32	Date/time (end of measurement)
Name :	Field for operator signature
	Blank line
-----	Dotted line

# Data Interface

## Purpose

Your balance/scale comes equipped with an interface port for connection to a computer or other peripheral device. You can use an on-line computer to change, start and/or monitor the functions of the balance/scale and the application programs.

## Female interface connector

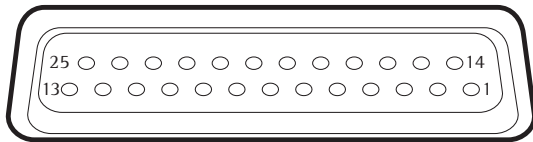

Pin Assignment Chart, 25-pin female interface connector, RS-232:

- Pin 1: Shield
- Pin 2: Data output (TxD)
- Pin 3: Data input (RxD)
- Pin 4: Internal ground (GND)
- Pin 5: Clear to Send (CTS)
- Pin 6: Not connected
- Pin 7: Internal ground (GND)
- Pin 8: Internal ground (GND)
- Pin 9: Not connected
- Pin 10: Not connected
- Pin 11: Charging voltage for rechargeable battery pack  
+12 ... +20 V (1 \_ out 25mA)
- Pin 12: Reset \_ Out \*)
- Pin 13: +5 V output
- Pin 14: Internal ground (GND)
- Pin 15: Universal remote switch
- Pin 16: Not connected
- Pin 17: Not connected
- Pin 18: Not connected
- Pin 19: Not connected
- Pin 20: Data Terminal Ready (DTR)
- Pin 21: Internal ground (GND)
- Pin 22: Not connected
- Pin 23: Not connected
- Pin 24: Not connected
- Pin 25: +5 V output

## Preparation

You can set these parameters for other devices in the Setup menu (see the chapter entitled “Configuring the Balance/Scale”). You will also find a detailed description of the available data interface commands in the file “Data Interface Descriptions for AZ, GD, GE and TE Models”, which you can download from the Sartorius website ([www.sartorius.com](http://www.sartorius.com) “Download Center”).

The many and versatile properties of these balances/scales can be fully utilized for printing out records of the results when you connect your balance/scale to a Sartorius data printer. The recording capability for printouts makes it easy for you to work in compliance with ISO/GLP.

\*) = Hardware restart

# Error Codes

Error codes are shown on the main display for 2 seconds. The program then returns automatically to the previous mode (e.g., weighing).

Display	Cause	Solution
No segments appear on the display	No AC power is available The AC adapter is not plugged in Battery or rechargeable battery pack is discharged	Check the AC power supply Plug in the AC adapter Replace the battery or recharge the battery pack using an external charger
H	The load exceeds the balance/scale capacity	Unload the balance/scale
L and E 54	The weighing pan is not in place Something is touching the weighing pan	Place the weighing pan on the balance/scale Move that object that is touching the weighing pan
E 02	Calibration parameter not met, e.g.: – balance/scale not zeroed – balance/scale is loaded	Unload the balance/scale Press (Tare) to tare the balance/scale Calibrate only when zero is displayed
E 09	When gross value $\leq$ zero; no tare	Tare the balance/scale
E 10	The (Tare) key is blocked when there is data in the second tare memory (net-total). Only 1 tare function can be used at a time	Press (CF) to clear the tare memory and release the tare key
E 11	Value input is not allowed for second tare memory	Press (Tare)
E 22	Weight is too light or there is no sample on the balance/scale	Increase the weight on the balance/scale
E 30	Interface port for printer output is blocked	Contact your local Sartorius Service Center
Max. weighing capacity is less than indicated under “Specifications”	The balance/scale was turned on without the weighing pan in place	Place the weighing pan on the balance/scale and press (I/O) to turn the balance/scale back on
The weight readout is obviously wrong	The balance/scale has not been calibrated/adjusted The balance/scale was not tared before weighing	Calibrate/adjust the balance/scale Tare the balance/scale

**If any other errors occur, contact your local Sartorius Service Center!**

---

## Care and Maintenance

### Service

Regular servicing by a Sartorius technician will extend the service life of your balance/scale and ensure its continued weighing accuracy. Sartorius can offer you service contracts, with your choice of regular maintenance intervals ranging from 1 month to 2 years. The optimum maintenance interval depends on the operating conditions at the place of installation and on the individual tolerance requirements.

### Repairs

Repair work must be performed by trained service technicians. Any attempt by untrained persons to perform repairs may lead to hazards for the user.

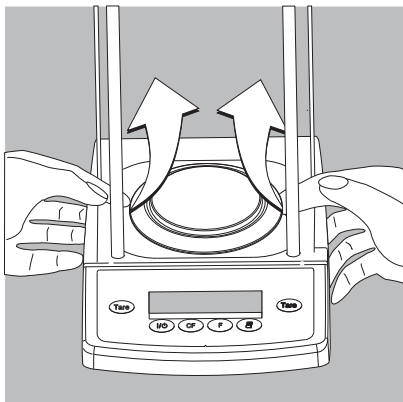

### Cleaning

- Unplug the AC adapter from the wall outlet (mains supply). If you have an interface cable connected to the balance/scale port, unplug it from the port,
- Clean the balance/scale using a piece of cloth which has been wet with a mild detergent (soap)
- After cleaning, wipe down the balance/scale with a soft, dry cloth.

Removing and Cleaning the Weighing Pan:

- Lift up and remove the weighing pan together with the pan support by gripping them from under the shield ring. Make sure that you do not damage the weighing system in doing so.
- ⚠ Make sure that no liquid enters the balance/scale housing.
- ⚠ Do not use any aggressive cleaning agents (solvents or similar agents).

### Cleaning Stainless Steel Surfaces

Clean all stainless steel parts regularly. Remove the stainless steel weighing pan and thoroughly clean it separately. Use a damp cloth or sponge to clean any stainless steel parts on the balance/scale. Only use commercially available household cleaning agent that is suitable for use on stainless steel. Clean stainless steel surfaces by wiping them down. Then rinse thoroughly, making sure to remove all residues. Afterwards, allow the balance/scale to dry. If desired, you can apply oil to the cleaned surfaces as additional protection. Solvents are permitted for use only on stainless steel parts.

---

### **Safety Inspection**

If there is any indication that safe operation of the balance/scale with the AC adapter is no longer warranted:

- Turn off the power and disconnect the equipment from AC power immediately
- > Lock the equipment in a secure place to ensure that it cannot be used for the time being

In this case, notify your nearest Sartorius Service Center or the International Technical Support Unit based in Goettingen, Germany.

Maintenance and repair work may only be performed by service technicians who are authorized by Sartorius.

### **Instructions for Recycling**

To ensure adequate protection for safe shipment, your balance/scale has been packaged to the extent necessary using environmentally friendly materials. After successful installation of the balance/scale, you should return this packaging for recycling because it is a valuable source of secondary raw material. For information on recycling options, including recycling of old weighing equipment, contact your municipal waste disposal center or local recycling depot.

# Overview

## Specifications

### Talent Series

Model		TE214S	TE124S	TE64
Weighing capacity	g	210	120	60
Readability	mg	0.1	0.1	0.1
Tare range (subtractive)	g	210	120	60
Repeatability	≤±mg	0.1	0.1	0.1
Linearity	≤±mg	0.2	0.2	0.2
Operating temperature range		+10...+30 °C (50°F to 86°F)		
Allowable ambient operating temperature		+5...+40°C (41°F to 104°F)		
Sensitivity drift within +10...+30 °C (50°F–86°F)	≥±/K	2 · 10 <sup>-6</sup>	2 · 10 <sup>-6</sup>	2 · 10 <sup>-6</sup>
Response time (average)	s	3	3	3
Adaptation to ambient conditions		By selection of 1 of 4 optimized filter levels		
Display update (depends on the filter level selected)	s	0.2–0.4	0.2–0.4	0.2–0.4
External calibration weight (of at least accuracy class)	g lb	200 (E2) 0.4	100 (E2) 0.2	50 (E2) 0.1
Net weight, approx.	kg	3.2	3.2	3.2
Pan size	mm	90 Ø	90 Ø	90 Ø
Weighing chamber height	mm	200	200	200
Dimensions (WxDxH)	mm	200×270×299		
AC power source/ power requirements		AC adapter 230 V or 115 V, +15% to –20%		
Frequency		48–60 Hz		
AC power source, direct current	V	10–20		
Power consumption (average)	W	1	1	1
Hours of operation with the YRB08Z rechargeable battery pack	h	20	20	20

## Gem Series

Model		GD603	GD103	GD502-DS	GD252, GD252-DS
Weighing capacity		605 ct/121 g	185 ct/37 g	505 ct/101 g	255 ct/51 g
Readability		0.001 ct/0.2 mg	0.001 ct/0.2 mg	0.005 ct	0.005 ct
Tare range (subtractive)		605 ct/121 g	185 ct/37 g	505 ct/101 g	255 ct/51 g
Repeatability	≤±	0.001 ct/0.2 mg	0.001 ct/0.2 mg	0.0075 ct	0.0075 ct
Linearity	≤±	0.002 ct/0.4 mg	0.002 ct/0.4 mg	0.015 ct	0.015 ct
Operating temperature range		+10...+30 °C (50°F to 86°F)			
Allowable ambient operating temperature		+5.... +40°C (41°F to 104°F)			
Sensitivity drift within +10...+30 °C	≤±/K	2·10 <sup>-6</sup>	2·10 <sup>-6</sup>	4·10 <sup>-6</sup>	4·10 <sup>-6</sup>
Response time (average)	s	3	3	2,5	2,5
Adaptation to ambient conditions		By selection of 1 of 4 optimized filter levels			
Display update (depends on the filter level selected)	s	0.2–0.4	0.2–0.4	0.2–0.8	0.2–0.8
External calibration weight (of at least accuracy class)	g	100 (F1)	20 (F1)	50 (F1)	50 (F1)
Net weight, approx.	kg	3.0	3.0	1.7/2.7	1.7/2.7
Pan size	mm	90 Ø	90 Ø	100 Ø	100 Ø
Weighing chamber height	mm	133	133	133	GD252-DS: 133
Dimensions (B×T×H)	mm	200×270×233	200×270×233	200×270×233	200×270×120/ 200×270×233
AC power source/ power requirements		AC adapter 230 V or 115 V, +15% to –20%			
Frequency		48–60 Hz			
AC power source/ direct current	V	10–20			
Power consumption (average) W		1	1	0.75	0.75
Hours of operation with the YRB08Z rechargeable battery pack	h	20	20	25	25

## Talent and Gold Series

Model		TE313S, TE313S-DS	TE153S, TE153S-DS	TE3102S, GE3102	GE2102
Weighing capacity	g	310	150	3,100	2,100
Readability	g	0.001	0.001	0.01	0.01
Tare range (subtractive)	g	310	150	3,100	2,100
Repeatability	≤±g	0.001	0.0015	0.01	0.015
Linearity	≤±g	0.002	0.003	0.02	0.04
Operating temperature range		+10...+30 °C (50° to 86°F)			
Allowable ambient operating temperature		+5... +40°C (41°F to 104°F)			
Sensitivity drift within +10...+30 °C	≤± /K	4·10 <sup>-6</sup>	4·10 <sup>-6</sup>	3·10 <sup>-6</sup>	4·10 <sup>-6</sup>
Response time (average)	s	3	2.5	2.5	2.5
Adaptation to ambient conditions		By selection of 1 of 4 optimized filter levels			
Display update (depends on the filter level selected)	s	0.2–0.8			
External calibration weight (of at least accuracy class)	g lb*	200 (E2) 0.4	100 (F1) 0.2	2000 (E2) 4	2000 (F1) –
Net weight, approx.	kg	2.2/3.2	1.7/2.7	2.2	1.7
Pan size	mm	100 Ø	100 Ø	174×143	174×143
Dimensions (B×T×H)	mm	200×270×120/ TE...-DS: 200×270×299		200×270×70	
AC power source/ power requirements		AC adapter 230 V or 115 V, +15% to -20%			
Frequency		48–60 Hz			
AC power source/ direct current	V	10–20			
Power consumption (average)	W	0.75			
Hours of operation with the YRB08Z rechargeable battery pack	h	20	25	20	20

\* = only for TE models

## Talent and Gold Series

Model		TE1502S	GE1302	GE812	GE612, TE612, TE612-L
Weighing capacity	g	1,500	1,300	810	610
Readability	g	0.01	0.01	0.01	0.01
Tare range (subtractive)	g	1,500	1,300	810	610
Repeatability	≤±g	0.015	0.015	0.01	0.01
Linearity	≤±g	0.03	0.03	0.02	0.02
Operating temperature range		+10...+30 °C (50° to 86°F)			
Allowable ambient operating temperature		+5...+40°C (41°F to 104°F)			
Sensitivity drift within +10...+30 °C	≤± /K	4·10 <sup>-6</sup>	4·10 <sup>-6</sup>	5·10 <sup>-6</sup>	5·10 <sup>-6</sup>
Response time (average)	s	2.5	2.5	2	2
Adaptation to ambient conditions		By selection of 1 of 4 optimized filter levels			
Display update (depends on the filter level selected)	s	0.2–0.8			
External calibration weight (of at least accuracy class)	g lb*	1,000 (F1) 2	1,000 (F1) –	500 (F2) –	500 (F2) 1
Net weight, approx.	kg	1.7	1.7	1.4	1.4
Pan size	mm	174×143	174×143	116 Ø	116 Ø
Dimensions (B×T×H)	mm	200×270×70			
AC power source/ power requirements		AC adapter 230 V or 115 V, +15% to –20%			
Frequency		48 – 60 Hz			
AC power source/ direct current	V	10–20			
Power consumption (average)	W	0.75			
Hours of operation with – Mignon, AA alkaline manganese battery, approx.	h	–	–	50	50
– fully charged rechargeable 1000 mAh battery, approx.	h	–	–	20	20
Hours of operation with the YRB08Z rechargeable battery pack	h	25	25	25	25

\* = only for TE models

## Talent and Gold Series

Model		GE412, TE412, TE412-L	GE212, TE212, TE212-L	GE7101	TE6101, TE6101-L
Weighing capacity	g	410	210	7,100	6,100
Readability	g	0.01	0.01	0.1	0.1
Tare range (subtractive)	g	410	210	7,100	6,100
Repeatability	≤±g	0.01	0.01	0.1	0.1
Linearity	≤±g	0.02	0.02	0.2	0.2
Operating temperature range		+10... +30°C (50° to 86°F)			
Allowable ambient operating temperature		+5... +40°C (41°F to 104°F)			
Sensitivity drift within +10...+30 °C	≤± /K	0.5 · 10 <sup>-5</sup>	1 · 10 <sup>-5</sup>	0.5 · 10 <sup>-5</sup>	0.5 · 10 <sup>-5</sup>
Response time (average)	s	2	2	2	2
Adaptation to ambient conditions		By selection of 1 of 4 optimized filter levels			
Display update (depends on the filter level selected)	s	0.2–0.8			
External calibration weight (of at least accuracy class)	g lb*	200 (F2) 0.4	100 (M1) 0.2	5000 (F2) –	5000 (F2) 10
Net weight, approx.	kg	1.4	1.4	1.7	1.7
Pan size	mm	116 Ø	116 Ø	174×143	174×143
Dimensions (B×T×H)	mm	200×270×70			
AC power source/ power requirements		AC adapter 230 V or 115 V, +15% to -20%			
Frequency		48–60 Hz			
AC power source/ direct current	V	10–20			
Power consumption (average)	W	0.75			
Hours of operation with – Mignon, AA alkaline manganese battery, approx.	h	50			
– fully charged rechargeable 1000 mAh battery, approx.	h	20			
Hours of operation with the YRB08Z rechargeable battery pack	h	25			

\* = only for TE models

## Talent and Gold Series

Model		GE4101, TE4101, ...-L	GE2101, TE2101, ...-L	GE811	TE601, ...-L	TE12000, ...-L	TE6100, ...-L	TE4100, ...-L
Weighing capacity	g	4,100	2,100	810	610	12,000	6,100	4,100
Readability	g	0.1	0.1	0.1	0.1	1	1	1
Tare range (subtractive)	g	4,100	2,100	810	610	12,000	6,100	4,100
Repeatability	≤±g	0.1	0.1	0.1	0.1	1	1	1
Linearity	≤±g	0.2	0.2	0.2	0.2	2	2	2
Operating temperature range		+10...+30°C (50°F to 86°F)						
Allowable ambient operating temperature		+5.... +40°C (41°F to 104°F)						
Sensitivity drift within +10...+30 °C	≤±/K	1·10 <sup>-5</sup>	2·10 <sup>-5</sup>	5·10 <sup>-5</sup>	5·10 <sup>-5</sup>	2.5·10 <sup>-5</sup>	5·10 <sup>-5</sup>	5·10 <sup>-5</sup>
Response time (average)	s	2	1.5	1.5	1.5	1.5	1.5	1.5
Adaptation to ambient conditions		By selection of 1 of 4 optimized filter levels						
Display update (depends on the filter level selected)	s	0.2–0.8						
External calibration weight (of at least accuracy class)	kg lb*	2 (F2) 4	1 (M1) 2	0.5 (M1) 1	0.5 (M1) 1	5 (M1) 10	5 (M1) 10	2 (M1) 4
Net weight, approx.	kg	1.7						
Pan size	mm	174×143						
Dimensions (B×T×H)	mm	200×270×70						
AC power source/, power requirements		AC adapter 230 V or 115 V, +15% to -20%						
Frequency		48–60 Hz						
AC power source/direct current	V	10–20						
Power consumption (average)	W	0.75						
Hours of operation with – Mignon, AA alkaline manganese battery, approx.	h	50						
– fully charged rechargeable 1000 mAh battery, approx.	h	20						
Hours of operation with the YRB08Z rechargeable battery pack	h	25						

\* = only for TE models

## Specifications

### M-power Series

Model		AZ214	AZ124	AZ64
Weighing capacity	g	210	120	60
Readability	mg	0.1	0.1	0.1
Tare range (subtractive)	g	210	120	60
Repeatability	≤±mg	0.2	0.2	0.2
Linearity	≤±mg	0.3	0.3	0.3
Operating temperature range		+10...+30 °C (50°F to 86°F)		
Allowable ambient operating temperature		+5...+40°C (41°F to 104°F)		
Sensitivity drift within +10...+30 °C (50°F–86°F)	≥±/K	2 · 10 <sup>-6</sup>	2 · 10 <sup>-6</sup>	2 · 10 <sup>-6</sup>
Response time (average)	s	3	3	3
Adaptation to ambient conditions		By selection of 1 of 4 optimized filter levels		
Display update (depends on the filter level selected)	s	0.2–0.4	0.2–0.4	0.2–0.4
External calibration weight (of at least accuracy class)	g lb	200 (E2) 0.4	100 (E2) 0.2	50 (E2) 0.1
Net weight, approx.	kg	3.2	3.2	3.2
Pan size	mm	90 Ø	90 Ø	90 Ø
Weighing chamber height	mm	200	200	200
Dimensions (WxDxH)	mm	200×270×299		
AC power source/ power requirements		AC adapter 230 V or 115 V, +15% to –20%		
Frequency		48–60 Hz		
AC power source, direct current	V	10–20		
Power consumption (average)	W	1	1	1
Hours of operation with the YRB08Z rechargeable battery pack	h	20	20	20

## M-power Series

Model		AZ313	AZ153	AZ3102	AZ1502	AZ612
Weighing capacity	g	310	150	3,100	1,500	610
Readability	g	0.001	0.001	0.01	0.01	0.01
Tare range (subtractive)	g	310	150	3,100	1,500	610
Repeatability	≤±g	0.003	0.003	0.015	0.015	0.015
Linearity	≤±g	0.004	0.004	0.03	0.03	0.03
Operating temperature range		+10...+30 °C (50° to 86°F)				
Allowable ambient operating temperature		+5... +40°C (41°F to 104°F)				
Sensitivity drift within +10...+30 °C	≤±/K	4 · 10 <sup>-6</sup>	4 · 10 <sup>-6</sup>	3 · 10 <sup>-6</sup>	4 · 10 <sup>-6</sup>	5 · 10 <sup>-6</sup>
Response time (average)	s	3	3	2.5	2.5	2.5
Adaptation to ambient conditions		By selection of 1 of 4 optimized filter levels				
Display update (depends on the filter level selected)	s	0.2–0.8				
External calibration weight (of at least accuracy class)	g lb	200 (E2) 0.4	100 (F1) 0.2	2000 (E2) 4	1,000 (F1) 2	500 (F2) 1
Net weight, approx.	kg	2.2	1.7	2.2	1.7	1.4
Pan size	mm	100 Ø	100 Ø	174×143	174×143	116 Ø
Dimensions (B×T×H)	mm	200×270×120		200×270×70		
AC power source/ power requirements		AC adapter 230 V or 115 V, +15% to -20%				
Frequency		48–60 Hz				
AC power source/ direct current	V	10–20				
Power consumption (average)	W	0.75				
Hours of operation with – Mignon, AA alkaline manganese battery, approx.	h	–	–	–	–	50
– fully charged rechargeable 1000 mAh battery, approx.	h	–	–	–	–	20
Hours of operation with the YRB08Z rechargeable battery pack	h	20	25	20	25	25

## M-power Series

Model		AZ212	AZ6101	AZ4101	AZ2101	AZ601
Weighing capacity	g	210	6,100	4,100	2,100	610
Readability	g	0.01	0.1	0.1	0.1	0.1
Tare range (subtractive)	g	210	6,100	4,100	2,100	610
Repeatability	≤±g	0.015	0.1	0.1	0.1	0.1
Linearity	≤±g	0.03	0.3	0.3	0.3	0.3
Operating temperature range		+10... +30°C (50° to 86°F)				
Allowable ambient operating temperature		+5... +40°C (41°F to 104°F)				
Sensitivity drift within +10...+30 °C	≤±/K	1 · 10 <sup>-5</sup>	0,5 · 10 <sup>-5</sup>	1 · 10 <sup>-5</sup>	2 · 10 <sup>-5</sup>	5 · 10 <sup>-5</sup>
Response time (average)	s	2.5	2	2	2	1.5
Adaptation to ambient conditions		By selection of 1 of 4 optimized filter levels				
Display update (depends on the filter level selected)	s	0.2–0.8				
External calibration weight (of at least accuracy class)	g lb	100 (M1) 0.2	5000 (F2) 10	2 (F2) 4	1 (M1) 2	0.5 (M1) 1
Net weight, approx.	kg	1.4	1.7	1.7	1.7	1.7
Pan size	mm	116 Ø	174 × 143	174 × 143	174 × 143	174 × 143
Dimensions (B×T×H)	mm	200 × 270 × 70				
AC power source/ power requirements		AC adapter 230 V or 115 V, +15% to -20%				
Frequency		48–60 Hz				
AC power source/ direct current	V	10–20				
Power consumption (average)	W	0.75				
Hours of operation with – Mignon, AA alkaline manganese battery, approx.	h	50				
– fully charged rechargeable 1000 mAh battery, approx.	h	20				
Hours of operation with the YRB08Z rechargeable battery pack	h	25				

---

## Accessories (Options)

<b>Product</b>	<b>Order No.</b>
<b>Data printer</b> with date/time, statistics evaluation, transaction counter functions and LCD	<b>YDP20-OCE</b>
– Paper (5 rolls)	<b>6906937</b>
<b>Remote display</b>	
– reflective	<b>YRD02Z</b>
– for overhead projectors, transmissive	<b>YRD13Z</b>
<b>External rechargeable battery pack</b> with external battery charger (hours of operation: 20 or 40, depending on balance/scale model)	<b>YRB08Z</b>
<b>SartoConnect data transfer program for interfacing a Sartorius balance to a PC with a Windows 95/98 or NT operating system</b> This software enables you to transfer the data recorded by your balance to any PC application program (e.g., Excel).	<b>YSC01L</b>
<b>RS-232C interface cable</b> for PC connection, 25-pin	<b>7357312</b>
COM data interface for PC connection, 9-pin	<b>7357314</b>
<b>Universal remote control switch:</b>	
Foot switch with T-connector	<b>YFS01</b>
Hand switch with T-connector	<b>YHS02</b>
<b>T-connector</b> for connecting 2 peripheral devices	<b>YTC01</b>
<b>Carrying case</b> – for models with a readability $\geq 1$ mg	<b>YDB01TE</b>

<b>Product</b>	<b>Order No.</b>
<b>In-use dust cover</b>	
– Only over operating elements for models GD..., AZ214, AZ124, AZ64, TE214S, TE124S, TE64, TE...-DS	<b>6960TE01</b>
– for models with a rectangular weighing pan	<b>6960TE03</b>
– for models with a round weighing pan	<b>6960TE02</b>
Attaching the in-use dust cover to models with a glass draft shield:	
– Remove adhesive strip from balance/scale housing	
– Place dust cover on balance/scale	
– Stick adhesive strip on dust cover	
<b>Weighing bowls/scoops/gem trays</b>	
– 300 ml, weight 86 g, stainless steel	<b>6407</b>
– 1000 ml, weight 240 g, stainless steel	<b>641211</b>
– 300 ml, weight 22 g, aluminum	<b>69641304</b>
– 110 ml, 90 mm Ø, aluminum	<b>69GP0003</b>
– 270 ml, weight 62 g, 137 mm Ø, stainless steel	<b>YWP03G</b>
– 62 mm Ø, stainless steel	<b>6910848</b>
– 85 ml, 70 mm Ø, aluminum	<b>YWP06G</b>
– 180 ml, 90 mm Ø, aluminum	<b>YWP05G</b>
– 174 mm Ø, stainless steel	<b>YWP04G</b>
<b>Calibration weights</b>	
– for AZ3102, TE 3102S (2000 g; E2)	<b>YCW6228-00</b>
– for AZ313, AZ214, TE313S, TE214S (200 g, E2)	<b>YCW5228-00</b>
– for AZ124, TE124S (100 g, E2)	<b>YCW5128-00</b>
– for AZ64, TE64 (50 g, E2)	<b>YCW4528-00</b>
– for GD103 (20 g, F1)	<b>YCW4238-00</b>
– for GD252 (50 g, F1)	<b>YCW4538-00</b>
– for AZ153, GD603, TE153S (100 g, F1)	<b>YCW5138-00</b>
– for AZ1502, TE1502S, GE1302, GE4101,	
– for GE2102 (2000 g, F1)	<b>YCW6238-00</b>
TE4101, (1 kg, F1)	<b>YCW6138-00</b>
– for AZ612, GE812, GE612, GE811, TE601 (500 g, F2)	<b>YCW5548-00</b>
– for GE412, TE412 (200 g, F2)	<b>YCW5248-00</b>
– for AZ212, GE212, TE212 (100 g, F2)	<b>YCW5148-00</b>
– for AZ4101, TE4100 (2000 g, F2)	<b>YCW6248-00</b>
– for AZ2101, GE2101, TE2101 (1 kg, F2)	<b>YCW6148-00</b>
– for AZ6101, GE7101, TE6101, TE12000, TE6100 (5 kg, F2)	<b>YCW6548-00</b>
or alternative (5 kg; ± 0.25 mg)	<b>YSS653-00</b>



**sartorius**  
mechatronics

## **CE** EG-Konformitätserklärung *EC Declaration of Conformity*

Sartorius AG  
Weender Landstr. 94 - 108  
37075 Göttingen, Germany

erklärt, dass das Betriebsmittel  
*declares that the equipment*

Gerät: **Elektronische Analysenwaage / Präzisionswaage**  
*Apparatus: Electronic Analytical Balance / Precision Balance*

Baureihe / *Batch:* **AZ....., GD....., GE....., TE.....**

Typbezeichnung: **Siehe Anhang 1**  
*Type: See Annex 1*

mit den grundlegenden Anforderungen der folgenden Europäischen Richtlinien übereinstimmt:  
*complies with the basic requirements of the following European Directives:*

Richtlinie 2004/108/EG **Elektromagnetische Verträglichkeit**  
*Directive 2004/108/EC Electromagnetic compatibility*

Richtlinie 2006/95/EG **Elektrische Betriebsmittel zur Verwendung innerhalb bestimmter Spannungsgrenzen**  
*Directive 2006/95/EC Electrical equipment designed for use within certain voltage limits*

Das Gerät erfüllt die anwendbaren Anforderungen der in Anhang 2 aufgeführten harmonisierten Europäischen Normen.

*The apparatus meets the applicable requirements of the harmonized European Standards listed in Annex 2.*

Jahr der Anbringung des CE-Zeichens: **10**  
*Year of attachment of CE mark:*

Sartorius AG  
Göttingen, 2010-07-30



Dr. Reinhard Baumfalk  
Leitung Entwicklung  
Mechatronik  
*Vice President, R&D  
Mechatronics*

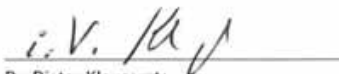

Dr. Dieter Klausgrete  
Leitung International Certification Management  
Mechatronik  
*Head of International Certification Management  
Mechatronics*



## EG-Konformitätserklärung *EC Declaration of Conformity*

### Anhang 1 / *Annex 1*

#### Typ / type:

AZ64	GD103	GE212	TE64	TE1502S
AZ124	GD252	GE412	TE124S	TE2101
AZ224	GD252-DS	GE612	TE153S	TE3102S
AZ153	GD502-DS	GE811	TE153S-DS	TE4100
AZ313	GD603	GE812	TE212	TE4100-L
AZ212		GE1302	TE212-L	TE4101
AZ601		GE2101	TE214S	TE6100
AZ612		GE2102	TE313S	TE6100-L
AZ1502		GE3102	TE313S-DS	TE6101
AZ3102		GE4101	TE412	TE6101-L
AZ2101		GE7101	TE412-L	TE12000
AZ4101			TE601	TE12000-L
AZ6101			TE601-L	
			TE612	
			TE612-L	

.....

### Anhang 2 / *Annex 2*

#### Liste der angewendeten harmonisierten Europäischen Normen *List of the applied harmonized European Standards*

##### 1. Richtlinie 2004/108/EG | *Directive 2004/108/EC*

EN 61326-1:2006 Elektrische Mess-, Steuer-, Regel- und Laborgeräte - EMV- Anforderungen - Teil 1: Allgemeine Anforderungen (IEC 61326-1:2005)  
*Electrical equipment for measurement, control and laboratory use - EMC requirements - Part 1: General requirements (IEC 61326-1:2005)*

##### 2. Richtlinie 2006/95/EG | *Directive 2006/95/EC*

EN 61010-1:2001 Sicherheitsbestimmungen für elektrische Mess-, Steuer-, Regel- und Laborgeräte - Teil 1: Allgemeine Anforderungen (IEC 61010-1:2001)  
*Safety requirements for electrical equipment for measurement, control, and laboratory use - Part 1: General requirements (IEC 61010-1:2001)*

.....

Sartorius AG  
Weender Landstrasse 94–108  
37075 Goettingen, Germany

Phone +49.551.308.0  
Fax +49.551.308.3289  
www.sartorius-mechatronics.com

Copyright by Sartorius AG,  
Goettingen, Germany.  
All rights reserved. No part  
of this publication may  
be reprinted or translated in  
any form or by any means  
without the prior written  
permission of Sartorius AG.  
The status of the information,  
specifications and illustrations  
in this manual is indicated  
by the date given below.  
Sartorius AG reserves the  
right to make changes to the  
technology, features,  
specifications and design of the  
equipment without notice.

Status:  
September 2010, Sartorius AG,  
Goettingen, Germany

Printed in Germany on paper that has  
been bleached without any use of chlorine  
W1A000 · KT  
Publication No.: WTE6001-e10096